



# POWERCOMMAND CLOUD™ REMOTE MONITORING SYSTEM



*“Cummins Digital Solutions will provide customers with the ability to manage their power system assets, globally”*



## Description

The PowerCommand Cloud™ is a robust and reliable remote monitoring system that provides information and send notifications to ensure your equipment is available when you need it.

With easy-to-use mobile and web application giving you instant access to your equipment enabling real-time monitoring and control so you can make the right decisions, right away — thus minimizing downtime and maximizing power system performance along with asset availability.

## Highlights

- Site and asset status at a glance
- Notifications
- Real-time Remote Monitoring through PowerCommand Cloud™
- Asset Control
- Convenient access through Web UI and Mobile app with multi-language support
- Multiple site and fleet management
- Secure data transmission and storage
- Data Trending with export capability
- Maintenance Alert based on recommended service interval
- PowerCommand Controls are supported by a worldwide network of independent distributors who provide parts, service and warranty support



## Features

- **Connectivity:** PowerCommand 500/550 Cloud Link N (CLN) supports Ethernet or Cellular.
- **Communication:** The PowerCommand 500/550 CL N communicates directly with the Power Generation Asset by communicating telemetry data and remote control capability to the PowerCommand Cloud™.
- **Monitoring:** The PowerCommand Web and Mobile app monitors customer account and site information along with monitoring asset data (generator, transfer switch, DMC products and sensors).
- **Integration with the QuietConnect™ Home Standby Generator:** PowerCommand Cloud solution is integrated within the Cummins Connect Cloud™ Web and Mobile App.
- **Asset Control:** The PowerCommand Web and Mobile app can control the Power Generation Asset via start, stop, exercise scheduler and fault reset commands.
- **Notification:** The PowerCommand Cloud has the capability to notify users of Warnings and Faults via email, push notification and indirect SMS (if supported by wireless carrier).
- **Account & Fleet Management:** The PowerCommand Web and Mobile app offers fleet management capability by giving visibility and remote control of Customer's assets.
- **Event Storage and Export:** The PowerCommand Cloud stores the event log while the web and mobile app enables the user to monitor the event logs.
- **Data Trending (Storage and Export):** The PowerCommand Cloud stores the data and the web app enables data export and graphing of data trends.
- **On Device Diagnostics:** The PowerCommand 500/550 Cloud Link N offers on-device diagnostics.
- **Software Update:** The PowerCommand 500/550 Cloud Link N enable gateway software update capability.
- **PC500/550 Remote Software Update:** PowerCommand Cloud Web app enables execution of remote software updates on the asset.
- **Supported Language:** The PowerCommand Cloud supports English, French, Spanish, Chinese (Simplified) and Brazilian-Portuguese.
- **Mobile App Support:** PowerCommand Cloud supports the following Mobile Apps for both iOS and Android: Connect Cloud and PowerCommand Cloud.
- **Third-Party Genset Support:** Integrate third-party power system equipment (Generator, Auto Transfer Switch) using CCM-G, CCM-T or Wired Genset solution to accomplish remote monitoring/controlling capabilities.
- **Maintenance Warning:** The PowerCommand Cloud supports user-configurable maintenance alerts with notification capability for all assets. The reminder interval can be based on Engine Hours or time.

# PowerCommand Cloud™ User Interface

Users can remotely access real-time information using mobile and web app.

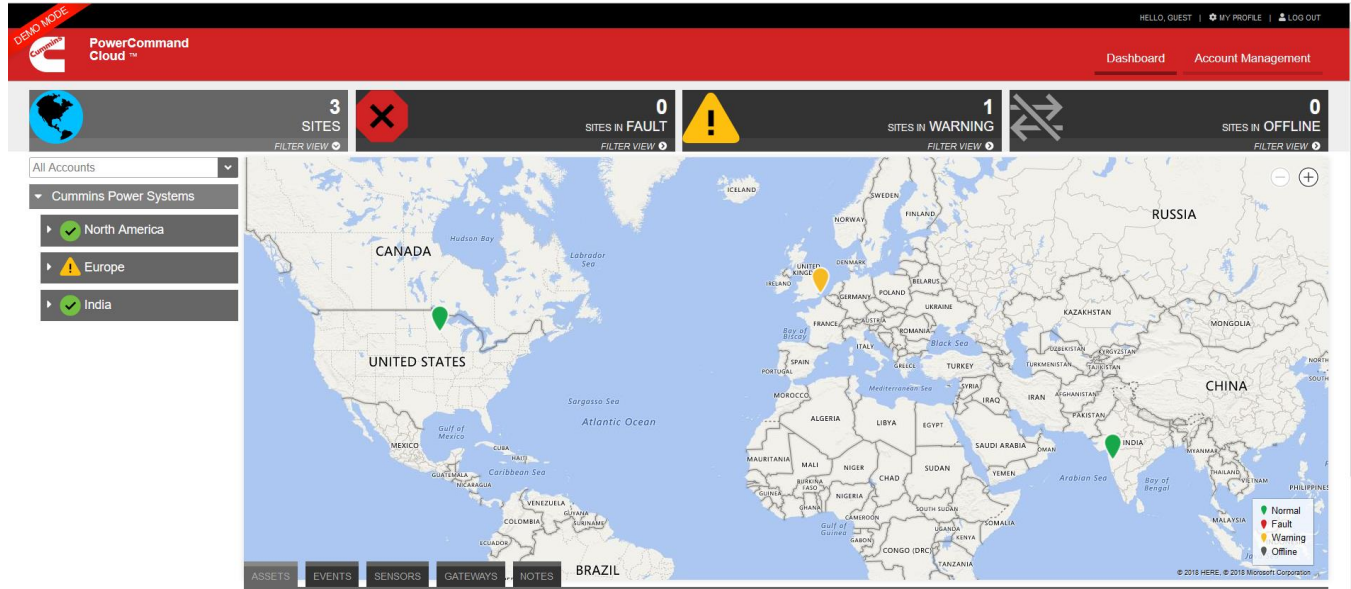

The web Dashboard allows users to view the status of all configured devices in one glance.

The Dashboard provides an overall system status at a glance that may include multiple sites and devices connected to the cloud. Users have the flexibility to filter assets by status and location and then access information about specific sites and equipment.

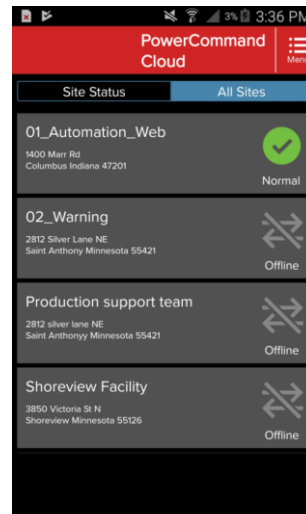
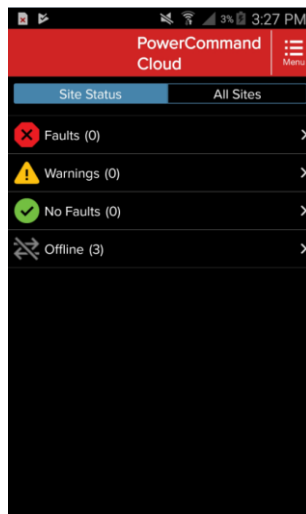

# Genset Information

The genset status and telemetry information is available via both the mobile app and web app.

The screenshot shows the 'Shoreview Facility' page in the PowerCommand Cloud web interface. It includes a header with 'PowerCommand Cloud' and navigation links for 'Dashboard' and 'Account Management'. The main content area displays the facility name and a list of details: Model (C100 D6), Serial Number, Control Model (P003300), and Description (Engine Model: 6BTA5.9G6, Standard Alternator: UG27AC, Frequency: 60Hz). A 'Run Status' section shows a green checkmark and 'Normal' status, with icons for 'Running', 'Remote Start', 'Remote Stop', and 'Fault Reset'. Below this is a 'DETAILS' tab with sub-tabs for 'EVENTS', 'DATA TRENDING', 'EXERCISE SCHEDULE', 'MAINTENANCE', and 'NOTES'. The 'EVENTS' sub-tab is active, showing a table of annunciator and alternator data.

Annunciator Data		Alternator Data				Engine Data	
Event	Status	L1	L2	L3	Units	Value	Units
Supplying Load	Running	199	199	204	V	27	V
Common Alarm	Not In Auto	115	119	116	V	1800	RPM
High Battery Voltage	Low Battery Voltage	2886	2886	2887	A	86	°C
Charger AC Failure	Fail To Start			60	Hz	-	°C
Low Coolant Temperature	Pre High Engine Temperature	Total kVA	1006		kVA	328.19	kPa
High Engine Temperature	Pre Low Oil Pressure	Total kW	621		kW	100	%
Low Oil Pressure	Engine Overspeed	Total Power Factor	0.63			-	L/hr
Low Coolant Level	Low Fuel Level	Engine Runtime	2.1		hr		
Check Genset	Ground Fault						
High AC Voltage	Low AC Voltage						
Under Frequency	Overload						
Overcurrent	Short Circuit						
Reverse kW	Reverse kVAR						
Fail To Sync	Fail To Close						
Load Demand	Genset Circuit Breaker Tripped						
Utility Circuit Breaker Tripped	Emergency Stop						

The screenshot shows the mobile app interface for PowerCommand Cloud. It features a red header with the app name and a menu icon. Below the header is a 'Data' section with a list of items: 'Alternator', 'Engine', and 'Annunciator', each with a right-pointing arrow. The app status bar at the top shows the time as 3:14 PM and battery level at 2%.

Updated at 03:13:57 PM

- **Asset Details:** Easy access to Generator's details such as model, serial number, and control model.
- **Annunciator Data:** This section displays the key status, warning and fault events where color coding is used (green, amber, red) depending on the event severity according to NFPA110.
- **Alternator Data:** User can access vital electrical genset information.
- **Engine Data:** Engine information is available in this section.
- **Exercise Scheduler:** User can set the Exercise Schedule for each asset.
- **Maintenance Alert:** PowerCommand Cloud will alert the user when Maintenance is required based on Engine Hours.
- **Data Trending:** The user can create graphs for a device by selecting a parameter and duration. In addition, asset data can be exported to .csv files.

The screenshot shows the 'DATA TRENDING' tab in the web interface. It includes a dropdown menu for 'Past 1 hour' and an 'EXPORT' button. A 'Select Parameters' list is visible with checkboxes for: Average Engine Speed (RPM), Battery Voltage (V), Coolant Temperature (°C), Engine Runtime (hr), Engine Starts, and Frequency (Hz).

Last Update: 8/31/2018 11:38:14 AM

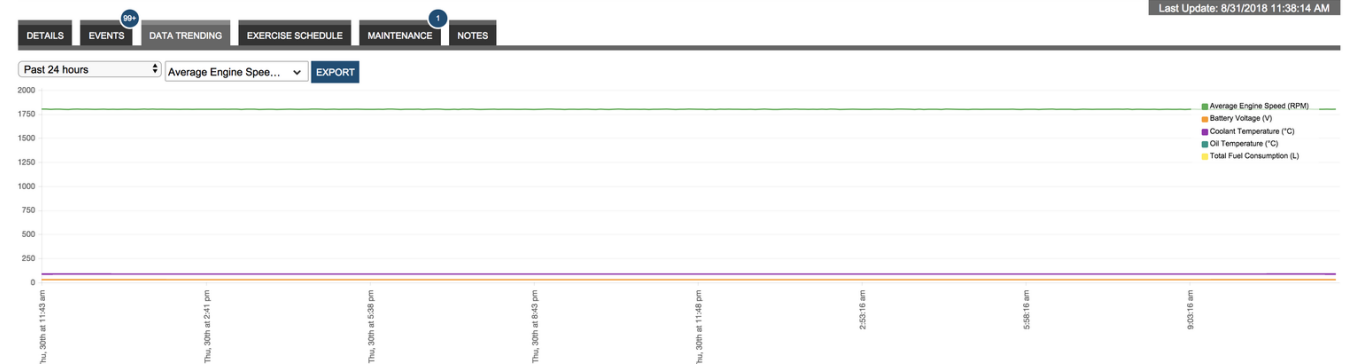

# Automatic Transfer Switch (ATS) Information

ATS status and telemetry information is available on the ATS page. The user can also to create data trend graphs for a particular device by selecting a parameter and duration.

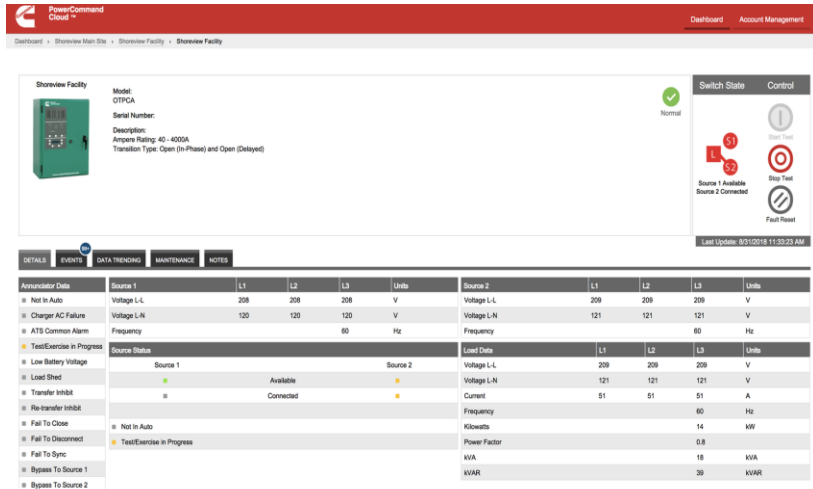
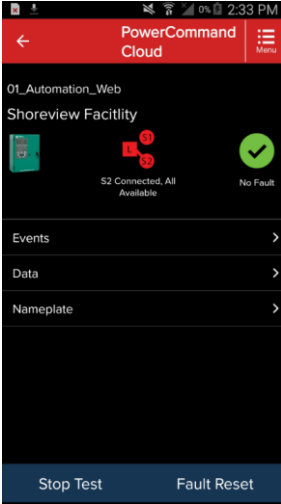

- **Asset Details:** Easy access to ATS's details such as model, serial number, and control model.
- **Annunciator Data:** This section displays the key status, warning and fault events where color coding is used (green, amber, red) depending on the event severity according to NFPA110.
- **Sources Data:** User can access vital electrical source information including status.
- **Load Data:** Load information is available in this section.
- **Data Trending:** The user can create graphs for a particular device by selecting a parameter and duration. In addition, asset data can be exported to .csv files.
- **Maintenance Alert:** PowerCommand Cloud will alert the user when Maintenance is required based on the recommended service intervals.

# Digital Master Control (DMC) Information

DMC status and telemetry information is available on the DMC page. The user can also to create data trend graphs for a particular device by selecting a parameter and duration.

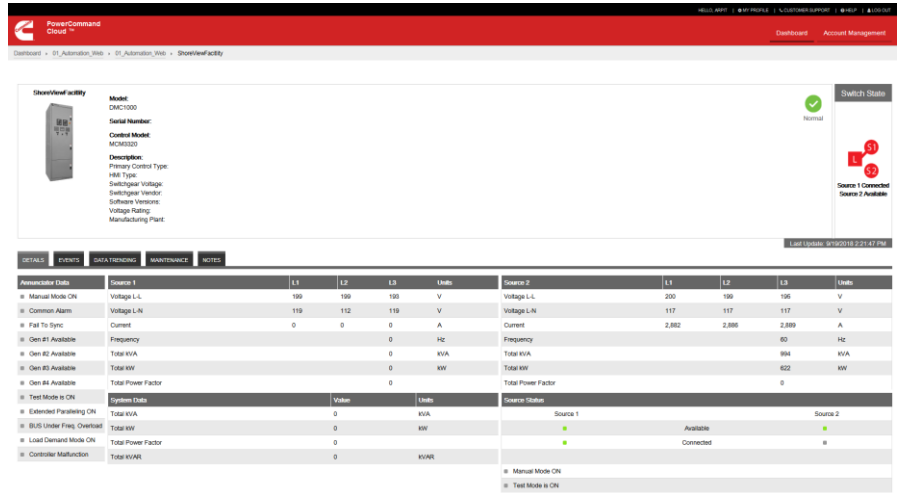
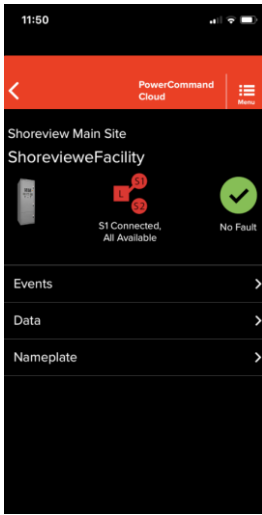

- **Asset Details:** Easy access to DMC details such as model, serial number, control model along with system information.
- **Events:** View operational events including Warning & Shutdowns along with the associated timestamps.
- **Data Trending:** The user can create graphs for a particular device by selecting a parameter and duration. In addition, asset data can be exported to .csv files.
- **Maintenance Alert:** PowerCommand Cloud will alert the user when Maintenance is required based on the recommended service intervals.

## Sensors

By selecting the Sensors tab the user can view all configured sensors in the inputs. In addition to device specific Inputs, the user can add an AUX 101 (8-configurable inputs) and an AUX 102 (4-non configurable discrete inputs) for additional remote monitoring capability. The Sensors Page displays configured sensors (states/values, low warnings and high warnings). Similar to the generator set and transfer switch data, the user can access specific event logs associated with all configured sensors.

## Notifications

Get notified when your equipment needs attention. PowerCommand Cloud™ sends notifications and gives you instant access to your equipment enabling real-time monitoring and control so you can make the right decisions, right away — thus minimizing downtime and maximizing power system performance.

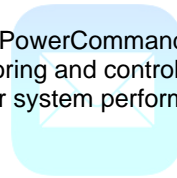

# Certifications



ICES-003B

## Dimensions of the PC 500/550 Cloud Link N

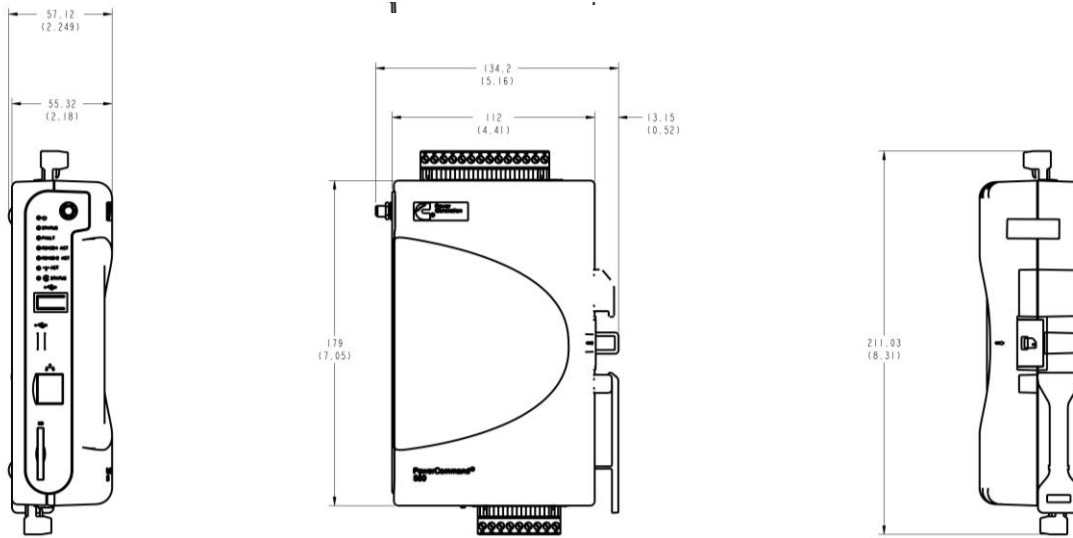

Dimensions are millimeters (inches)

# System requirements

## Web App

- PC or Macintosh computer, tablet, smart phone
- Browser: Internet Explorer, version 9.0 or later, Google Chrome, Firefox, Safari.
- Minimum screen resolution, 1024 x 768

## Gateway

- Browser: Internet Explorer, version 9.0 or later.
- Operating System: Microsoft Windows, Mac OS X or Linux
- HTML5 Support
- Windows Mobile Device Center
- Minimum screen resolution, 1024 x 768
- Network: 10/100-megabit Ethernet for the primary physical connection
- Port Specification:
  - MQTTS outgoing 168.61.54.255 uses port 8883 TCP
  - HTTPS outgoing 40.114.00.153 uses port 443 TCP
- The cellular service provider must have a network to support 3G service.
  - Frequency Band: 850/900/1700 (AWS)/1900/2100

## Language

The user interface and manuals are available in English, French, Spanish, Brazilian-Portuguese, and Chinese (Simplified).

# Hardware requirements

For installation and communication, the following additional hardware may be required:

- SIM card (GSM)
- Modbus cable
- Antenna extension cable
- PowerCommand Input/Output AUX 101 Module
- PowerCommand Input/Output AUX 102 Expansion Module

## Modbus controls

There is no additional hardware required for Modbus controls: PS0500, PS0600, DMC1000, PCC1301, 1302, 2300 and 3300.

## LonWorks controls

Required hardware for LonWorks-based controls: PCC2100, 3100, 3200 and 3201 generator set controls and OTPC, BTPC, OHPC and CHPC transfer switch controls:

- PowerCommand Lon Gateway S-6191
- PowerCommand Network Communications Module (NCM)
- ModLon Connection Cable

Additional hardware required for non-communicating OTEC, GTEC or third-party transfer switch controls and third-party generator set controls:

- PowerCommand Lon Gateway LonWorks to Modbus Converter
- PowerCommand Network Communication Module (CCM-G)
- PowerCommand Control Communication Module (CCM-T)
- PowerCommand Input/Output AUX 101 Module
- PowerCommand Input/Output AUX 102 Expansion Module

## Modbus communications

A shielded twisted pair cable, Belden 9729 cable or equivalent, is recommended for Modbus communication between the PowerCommand 500/550 Cloud Link N and any configured devices.

## Power supply requirements

The use of a power supply, with the following specification, is recommended. It is also recommended to connect the power supply and **PowerCommand 500/550 Cloud Link N** to an uninterruptible power supply (UPS).

Voltage range	12 to 24VDC
Current (12V typical)	250mA
Current (24V typical)	125mA
Power (typical)	3.0W
Power (maximum)	5.0W

## Environment

Operating temperature	-20°C to 70°C (-4°F to 158°F)
Storage temperature	-40°C to 85°C (-40°F to 185°F)
Humidity	85% RH, non-condensing

## Mounting and installation

PowerCommand 550/500 is DIN rail mountable and should be installed in a location suitable for telecommunications, information technology or networking equipment.



## Standard product contents

- PowerCommand 500 or 550 Cloud Link N
- Antenna (GSM)
- USB On-The-Go (OTG) cable
- Ethernet cable
- Quick Start Guide
- Quick Troubleshooting Guide
- Warranty Statement
- CD containing Owner's Manual, Quick Start Guide, Quick Troubleshooting Guide and Warranty Statement in English

## Accessories

- A035C381 Antenna Extension (12ft)
- 0541-1291 PowerCommand Input/Output AUX 101 Module
- 0541-0772 PowerCommand Input/Output AUX 102 Expansion Module
- A054V134 Lon Gateway - LonWorks to Modbus Converter
- 0541-0770 Network Genset Communications Module (NCM) for PCC 2100
- 0541-0813 Network Genset Communications Module (GCM) for PCC 3100
- 0541-0809 Network Genset Communications Module (NCM) for PCC 3200/3201
- 0541-0810 Controls Communications Module, generator set (CCM-G)
- 0541-0811 Controls Communications Module, transfer switch (CCM-T)
- 0541-0868 Network Communications Module (NCM) for OTPC/BTPC, >1000 A

## Ordering information

Part number	Description
A059Y211	PC 500 Cloud Link N (up to 2 devices)
A059Y210	PC 550 Cloud Link N (up to 12 devices)

For more information contact your local Cummins distributor or visit [power.cummins.com](http://power.cummins.com)

**Our energy working for you.™**

